

TP Series, Tiny

Features

- Compact design
- Round or rectangular actuator buttons.
- Vertical or right angle versions



Pushbutton Switches

Typical performance characteristics

Contact configuration SPST, SPDT, DPDT
 Contact timing Break-Before-Make
 Contact rating max. gold: 0.4VA @20VDC or peak AC
 silver: 1A @ 125VAC or 28 VDC resistive
 Electrical life 1 pole2 . . .2 pole
 gold 100,000 . . .80,000 cycles
 silver 60,000 . . .50,000 cycles
 Contact resistance, initial max.20 mOhms
 Insulation resistance 1,000 MOhms @ 500VDC
 Dielectric strength 1,000 Volts rms @ sea level
 Actuation force 0.5 to 4N (50-400gf)
 Actuator travel momentary .030" (.762)

Environmental specification

Operating temperature -30°C to +65°C
 Storage temperature -30°C to +65°C
 Solder heat resistance wave solder capable to 265° C

Material specifications

Contacts copper or brass, gold over nickel finish or silver
 clad with silver over nickel finish
 Actuator thermoplastic
 Terminals brass with gold over nickel or silver over nickel
 Case thermoplastic
 Frame and support bracket steel with tin over copper finish
 RoHS Directive 2002/95/EC compliant

Product key	Typical product key	TP	A	1	1	C	G	PC	0	04
Type	TP Tiny pushbutton series									
Bushing	blank square, no bushing A round, no bushing B round .188 (4.78) dia. bushing not threaded C round 10/48 UNS 2B thread D .250" (6.35) dia. bushing, not threaded F round 1/4-40 UNS 2B thread									
Actuator	blank standard F flush (available with B and C bushings only)									
Number of Poles	1 single pole 2 double pole									
Contact rating	1 0.4VA Gold 2 1.0 A Silver (Silver available only in wire lug and PC termination)									
Function	single pole C single throw, momentary F double throw, momentary CC dual function C - 2 x single throw, momentary FF dual function F - 2 x double throw, momentary	double pole M single throw, momentary R double throw, momentary								
Plating	G Gold blank Silver (Silver available only in wire lug and PC termination)									
Terminals	blank wire lug PC printed circuit board	RA right angle VRA vertical, right angle (available only in single pole)								
Button Color	0 black 2 red 6 blue									
Material	04 RoHS compliant									

TP Series, Tiny (Continued)

Bushing



blank, square, no bushing

printed circuit board



TP11CGPC004

Single pole

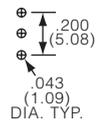
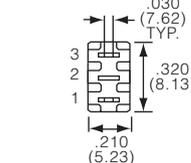
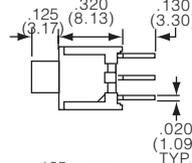
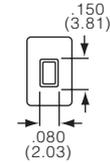

TP21CCGPC004

2 x Single pole (dual)

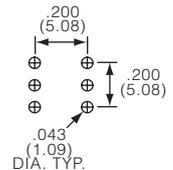
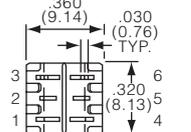
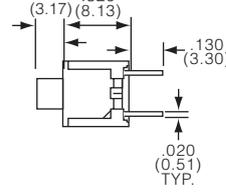
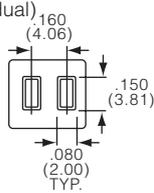

Note: no center terminal on 'C' and 'M' function switch

right angle



TP11CGRA004

Single pole

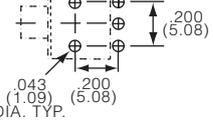
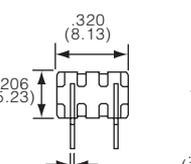
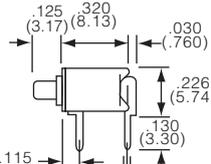
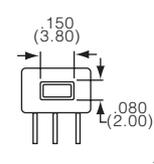

Note: no center terminal on 'C' and 'M' function switch



TP21CCGRA004

2 x Single pole (dual)

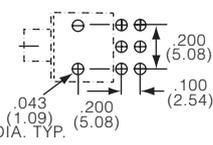
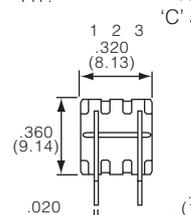
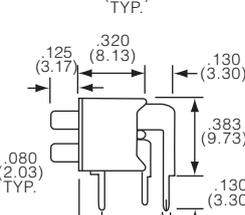
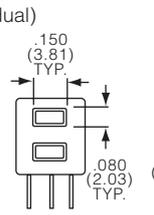

A, Round, no bushing

printed circuit board



TPA11CGPC004

Single pole

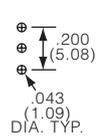
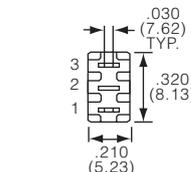
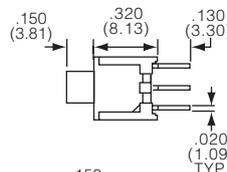
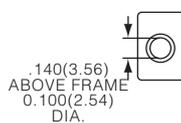

2 x Single pole (dual)

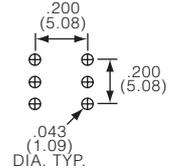
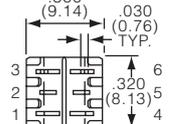
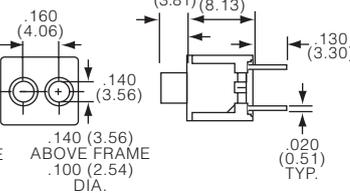
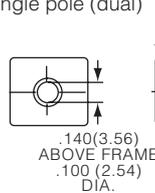

Note: no center terminal on 'C' function switch

TP Series, Tiny (Continued)

right angle



Single pole

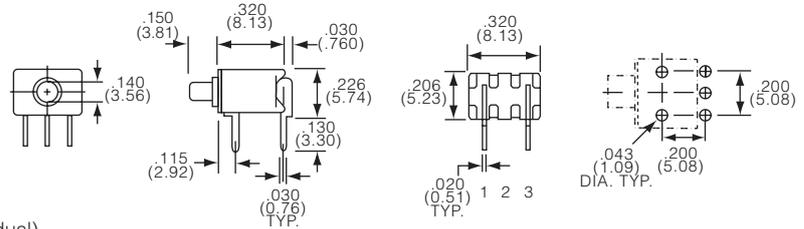

2 x Single pole (dual)

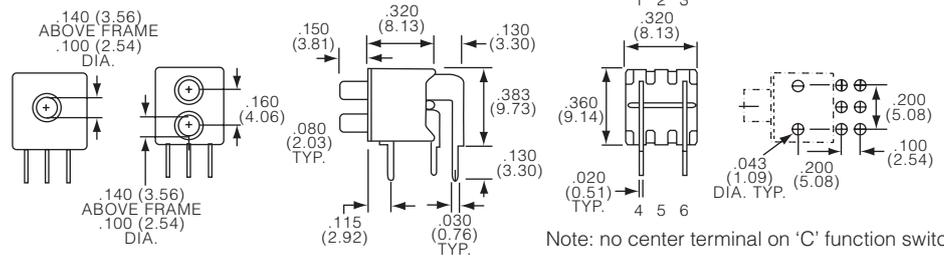

Note: no center terminal on 'C' function switch

B, Round .188 (4.78) dia. bushing not threaded

printed circuit board

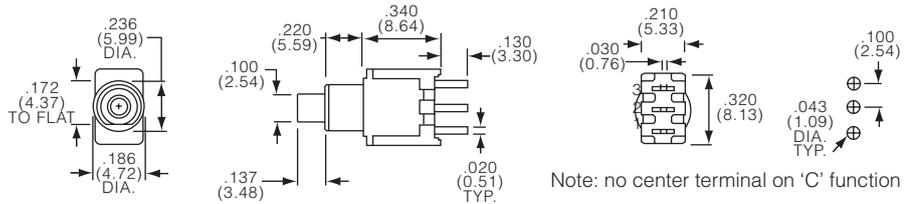

Note: no center terminal on 'C' function switch

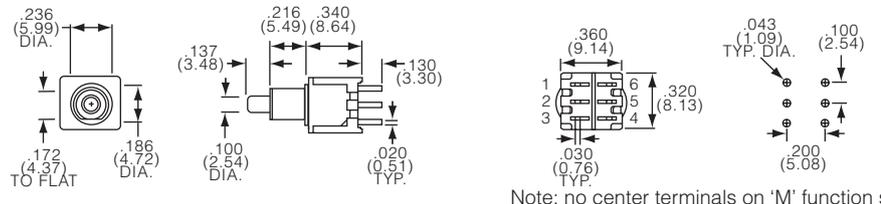

Note: no center terminals on 'M' function switch

right angle

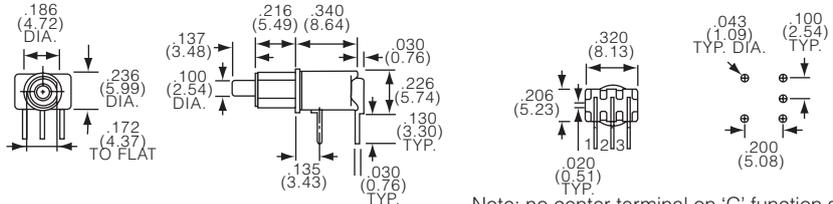

Note: no center terminal on 'C' function switch

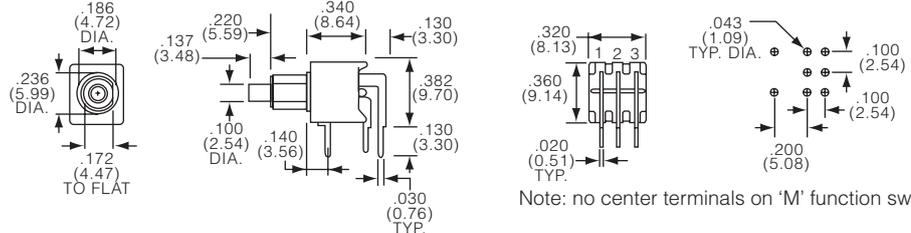

Note: no center terminals on 'M' function switch

TP Series, Tiny (Continued)

vertical right angle

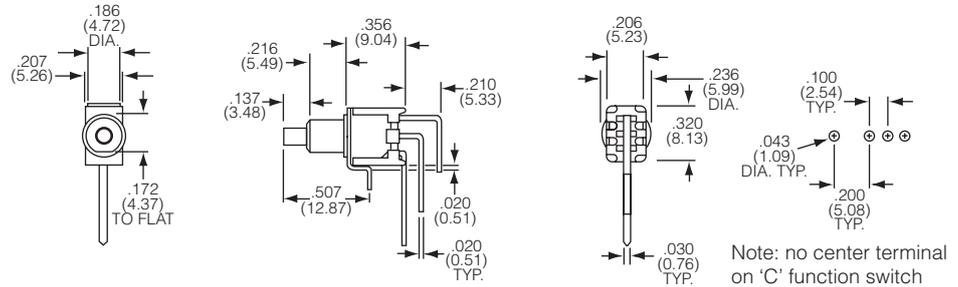

printed circuit board, flush actuator

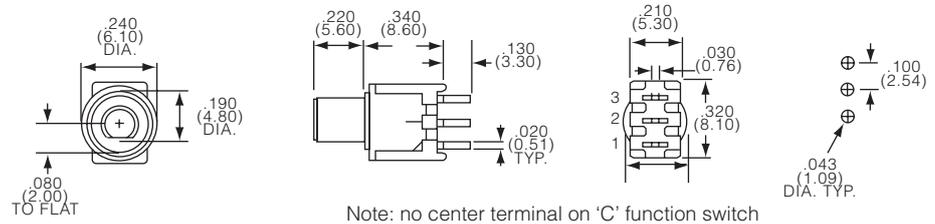

right angle, flush actuator

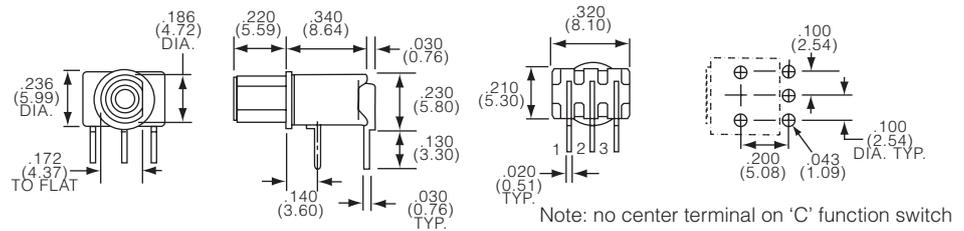

C, Round 10/48 UNS 2B thread

wire lug

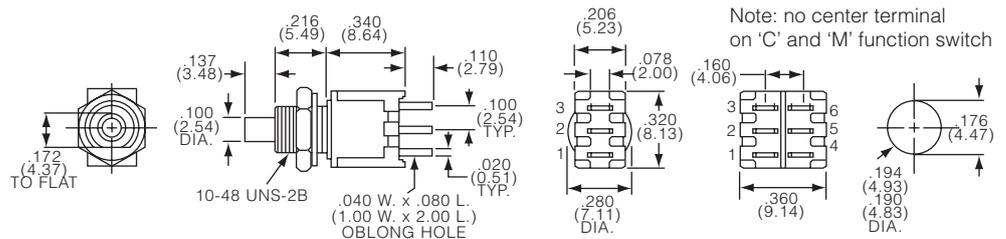

printed circuit board

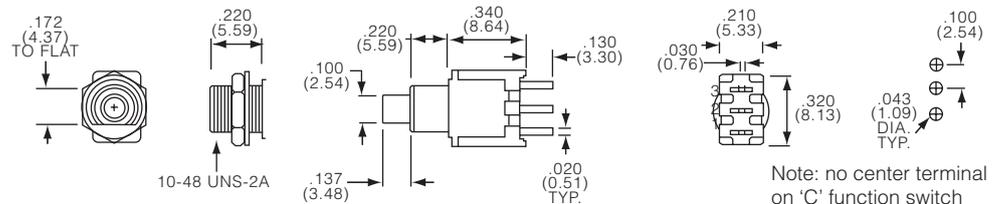

Pushbutton Switches

TP Series, Tiny (Continued)

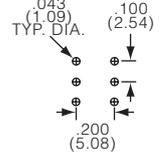
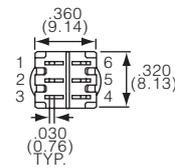
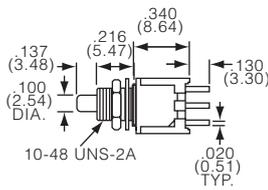

Note: no center terminals on 'M' function switch

right angle

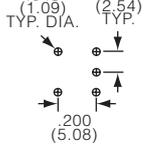
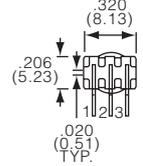
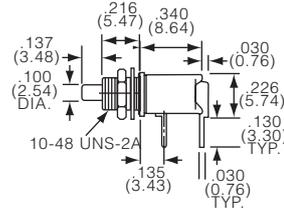

Note: no center terminal on 'C' function switch

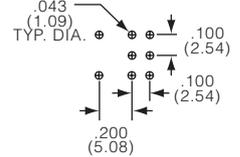
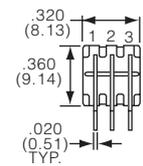
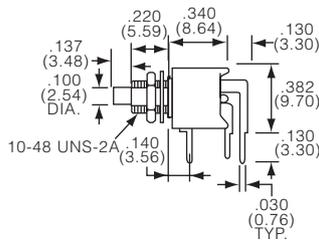

Note: no center terminals on 'M' function switch

vertical right angle

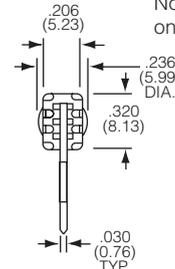
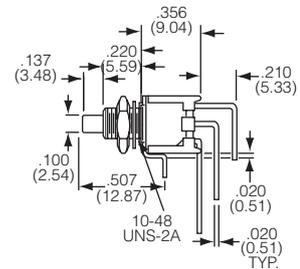
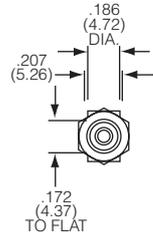

Note: no center terminal on 'C' function switch

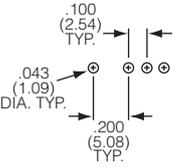

wire lug, flush actuator

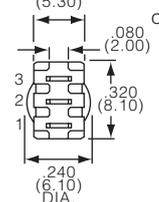
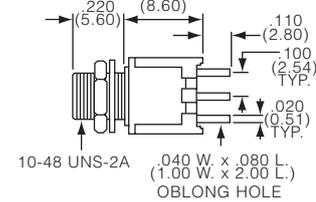
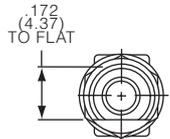

Note: no center terminal on 'C' function switch

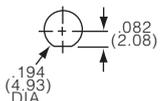

printed circuit board, flush actuator

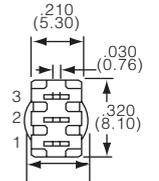
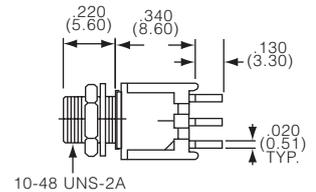
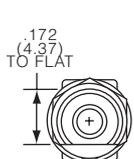

Note: no center terminal on 'C' function switch

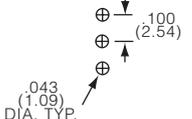

TP Series, Tiny (Continued)

right angle, flush actuator

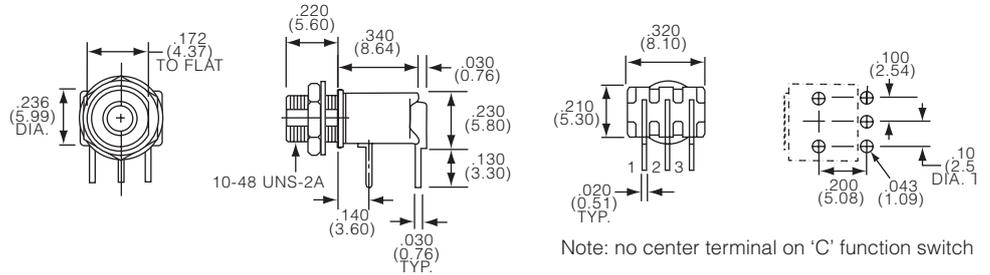

D, .250" (6.35) dia. bushing, not threaded

printed circuit board

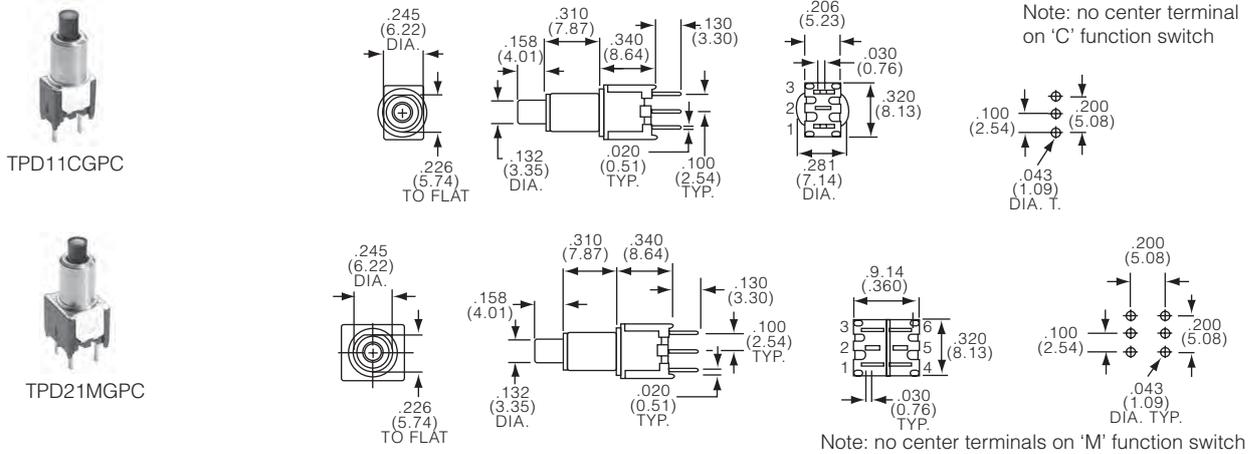

right angle

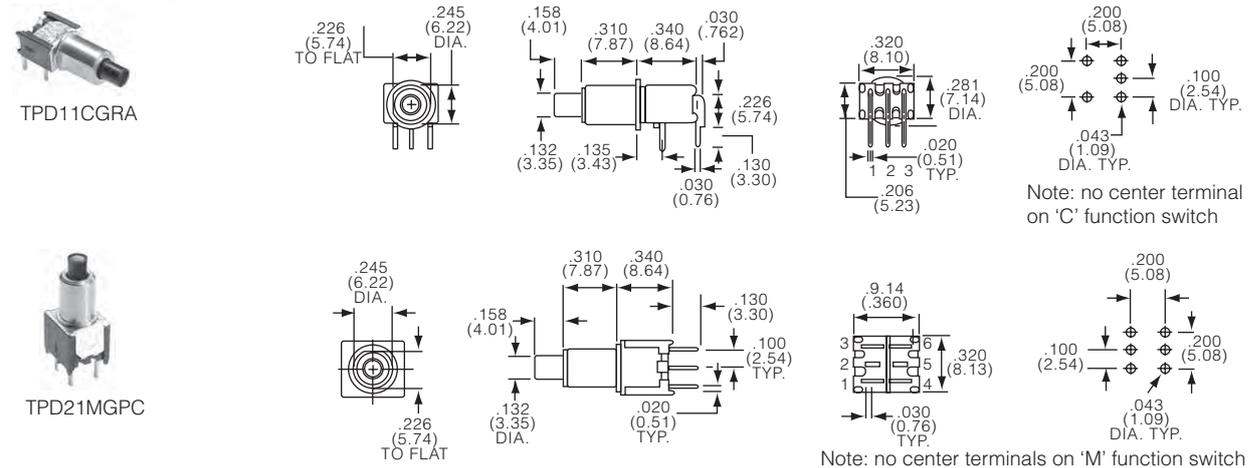

TP Series, Tiny (Continued)

F, Round 1/4-40 UNS 2B thread

wire lug

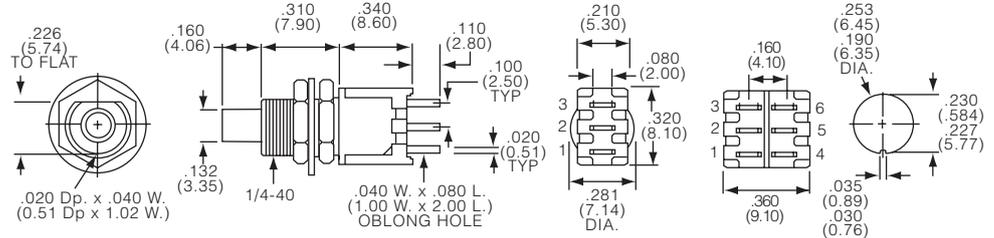

Note: no center terminal on 'C' and 'M' function switch

printed circuit board

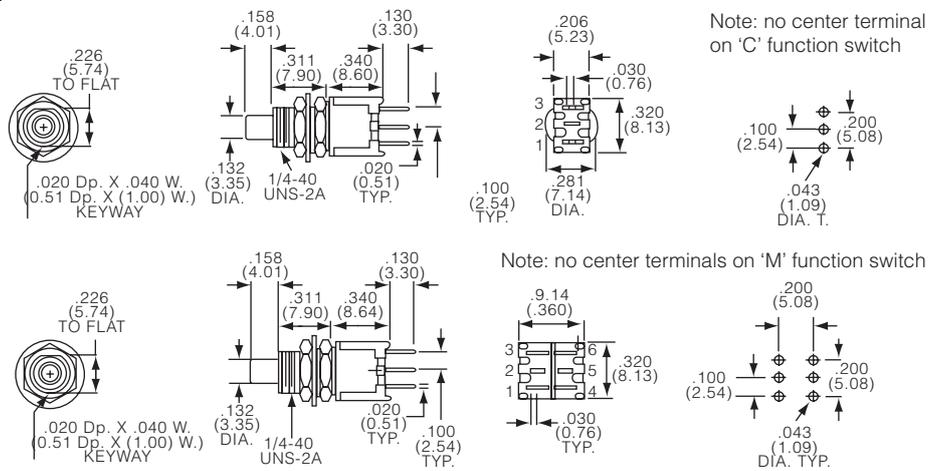

Pushbutton Switches

right angle

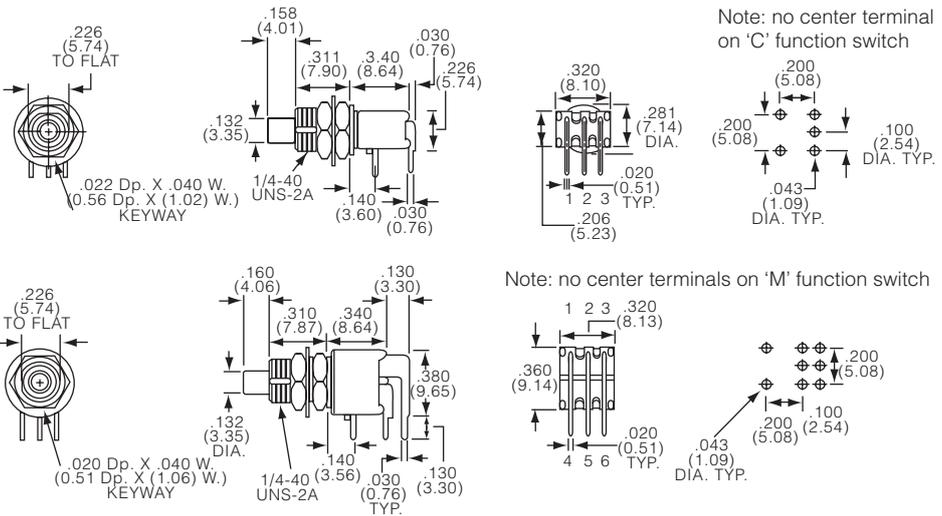

TP Series, Tiny (Continued)

Product key	Bushing	Act.	Poles	Rating	Function			Plating	Terminals	Btn.	Material	Part Number
TP11CGPC004	square	n/a	1	0.4VA	Off-(On)	Off	1-3	Gold	pcb	black	RoHS	1825095-1
TP11CGPC204	no bushing									red	compliant	1825095-2
TP11CGRA004									right angle	black		1825095-3
TP11CGRA204										red		1825095-4
TP11CGRA604										blue		1825095-5
TP11FGPC004					On-(On)	1-2	2-3		pcb	black		1825095-6
TP11FGPC204										red		1825095-7
TP11FGRA004									right angle	black		1825095-8
TP11FGRA204										red		1825095-9
TP11FGRA604										blue		1-1825095-0
TP21CCGRA004			2 (1+1)		Off-(On)	Off	1-3			black		1-1825095-1
TP21CCGRA204										red		1-1825095-2
TP21FFGRA004					On-(On)	1-2	2-3			black		1-1825095-3
TPA11CGPC004	round		1		Off-(On)	Off	1-3		pcb			1825096-1
TPA11CGPC204	no bushing									red		1825096-2
TPA11CGPC604										blue		1825096-3
TPA11CGRA004									right angle	black		1825096-4
TPA11CGRA204										red		1825096-5
TPA11CGRA604										blue		1825096-6
TPA11FGPC004					On-(On)	1-2	2-3		pcb	black		1825096-7
TPA11FGPC204										red		1825096-8
TPA11FGPC604										blue		1825096-9
TPA11FGRA004									right angle	black		1-1825096-0
TPA11FGRA204										red		1-1825096-1
TPA11FGRA604										blue		1-1825096-2
TPA21CCGPC004			2 (1+1)		Off-(On)	Off	1-3, 4-6		pcb	black		1-1825096-3
TPA21CCGRA004									right angle			1-1825096-4
TPA21FFGRA204					On-(On)	1-2, 4-5	2-3, 5-6			red		1-1825096-5
TPA21MGRA004			2		Off-(On)	Off	1-3, 4-6			black		1-1825096-6
TPB11CGPC004	round	std	1				1-3		pcb			1825097-1
TPB11CGPC204	.188 (4.78)									red		1825097-2
TPB11CGRA004	dia								right angle	black		1825097-6
TPB11CGRA204	bushing,									red		1825097-4
TPB11CGVRA004	not								vertical r.a.	black		1825097-8
TPB11FGPC004	threaded				On-(On)	1-2	2-3		pcb			1825097-9
TPB11FGRA004									right angle			1-1825097-1
TPB11FGRA204										red		1-1825097-2
TPB11FGRA604										blue		1-1825097-3
TPB11FGVRA004									vertical r.a.	black		1-1825097-6
TPB21MGPC004			2		Off-(On)	Off	1-3, 4-6		pcb			1-1825097-7
TPB21MGPC204										red		1-1825097-8
TPB21MGRA004									right angle	black		2-1825097-8
TPB21RGRA004					On-(On)	1-2, 4-5	2-3, 5-6					1-1825097-9
TPB21RGRA0EDC04												1825112-1
TPBF11CGRA004		flush	1		Off-(On)	Off	1-3					2-1825097-1
TPBF11FGRA004					On-(On)	1-2	2-3					2-1825097-4
TPBF11FGRA204										red		2-1825097-5

Preferred parts in bold print

TP Series, Tiny (Continued)

Pushbutton Switches

Product key	Bushing	Act.	Poles	Rating	Function			Plating	Terminals	Btn.	Material	Part Number
TPC11CGPC004	round	std	1	0.4VA	Off-(On)	Off	1-3	Gold	pcb	black	RoHS	1825098-1
TPC11CGRA004	10/48								right angle		compliant	1825098-2
TPC11CGRA204	UNS 2B									red		1825098-3
TPC11CGVRA004	thread								vertical r.a.	black		1825098-4
TPC11FGPC004					On-(On)	1-2	2-3		pcb			1825098-5
TPC11FGRA004									right angle			1825098-6
TPC11FGVRA004									vertical r.a.			1825098-7
TPC11FGVRA204										red		1825098-8
TPC13C004				1.0 A	Off-(On)	Off	1-3	Silver	wire lug	black		1825098-9
TPC13C204										red		1-1825098-0
TPC13CPC004									pcb	black		1-1825098-1
TPC13F004					On-(On)	1-2	2-3		wire lug			1-1825098-2
TPC21MGRA204			2	0.4VA	Off-(On)	Off	1-3, 4-6	Gold	right angle	red		1-1825098-3
TPC21RGPC004					On-(On)	1-2, 4-5	2-3, 5-6		pcb	black		1-1825098-4
TPC23M004				1.0 A	Off-(On)	Off	1-3, 4-6	Silver	wire lug			1-1825098-5
TPC23R204					On-(On)	1-2, 4-5	2-3, 5-6			red		1-1825098-6
TPCF11CGPC004		flush	1	0.4VA	Off-(On)	Off	1-3	Gold	pcb	black		1-1825098-7
TPCF11CGRA004									right angle			1-1825098-8
TPCF11FGRA004					On-(On)	1-2	2-3					1-1825098-9
TPCF13C004				1.0 A	Off-(On)	Off	1-3	Silver	wire lug			2-1825098-0
TPCF13F004					On-(On)	1-2	2-3					2-1825098-1
TPD11CGPC004	.259 (6.35)	n/a		0.4VA	Off-(On)	Off	1-3	Gold	pcb			1825099-1
TPD11CGPC204	dia									red		1825099-2
TPD11CGRA004	bushing,								right angle	black		1825099-3
TPD11CGRA204	not									red		1825099-4
TPD11CGRA604	threaded									blue		1825099-5
TPD11FGPC004					On-(On)	1-2	2-3		pcb	black		1825099-6
TPD11FGRA004									right angle			1825099-7
TPD11FGRA204										red		1825099-8
TPD21MGRA004			2		Off-(On)	Off	1-3, 4-6			black		1825099-9
TPD21RGPC004					On-(On)	1-2, 4-5	2-3, 5-6		pcb			1-1825099-0
TPF11CGPC004	round		1		Off-(On)	Off	1-3					1825100-1
TPF11CGPC204	1/4-40									red		1825100-2
TPF11CGRA004	UNS 2B								right angle	black		1825100-4
TPF11CGRA204	thread									red		1825100-5
TPF11CGRA604										blue		1825100-6
TPF11FGPC004					On-(On)	1-2	2-3		pcb	black		1825100-7
TPF11FGPC204										red		1825100-8
TPF11FGPC604										blue		1825100-9
TPF11FGRA004									right angle	black		1-1825100-1
TPF13C004				1.0 A	Off-(On)	Off	1-3	Silver	wire lug			1-1825100-2
TPF13C204										red		1-1825100-3
TPF13F204					On-(On)	1-2	2-3					1-1825100-4
TPF13F604										blue		1-1825100-5
TPF21MGPC004			2	0.4VA	Off-(On)	Off	1-3, 4-6	Gold	pcb	black		1-1825100-6
TPF21RGRA004					On-(On)	1-2, 4-5	2-3, 5-6		right angle			1-1825100-7
TPF23M004				1.0 A	Off-(On)	Off	1-3, 4-6	Silver	wire lug			1-1825100-8